

5º PASSO

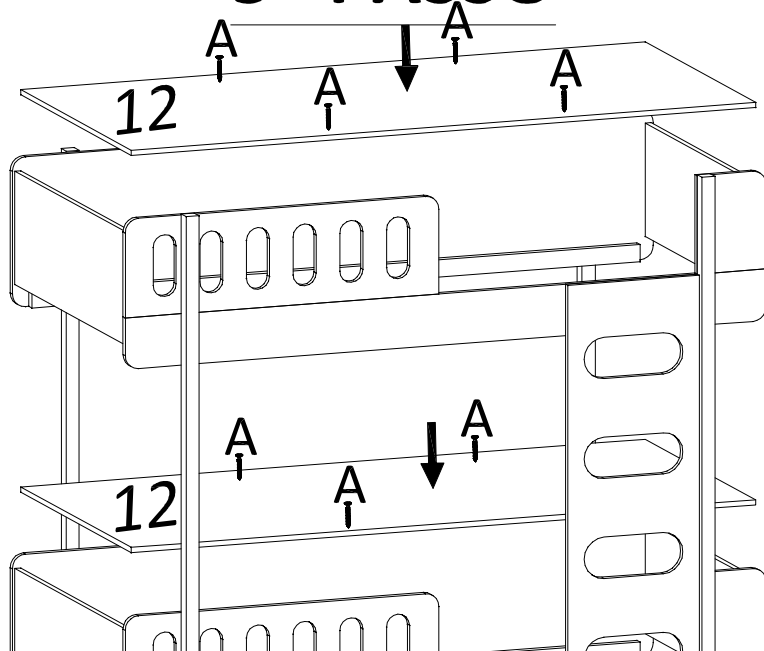

6º PASSO

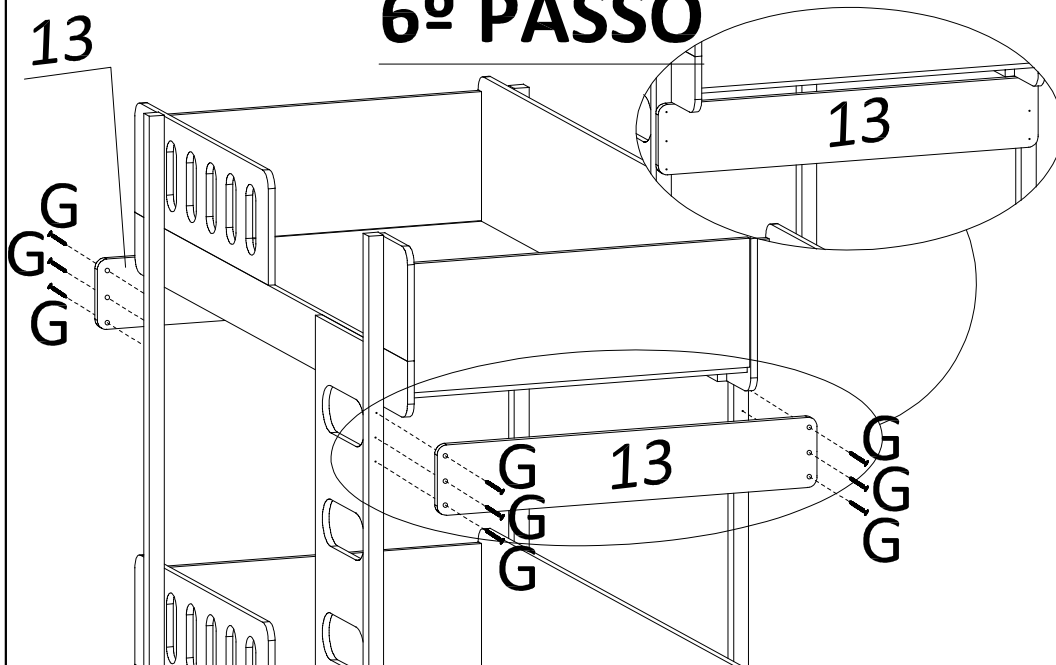

SOMNIARE

BABY FURNITURE

Beliche - LM 7024

ESQUEMA DE MONTAGEM

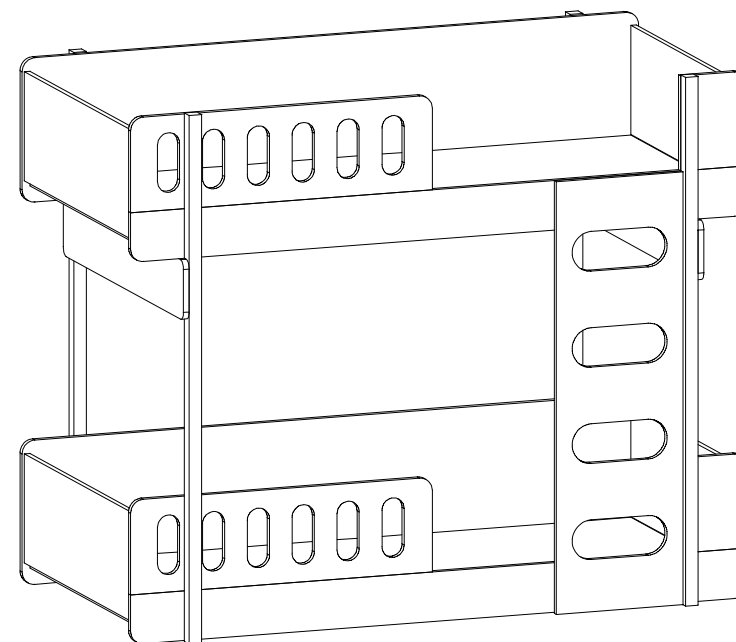

→ 1,950 m ↑ 1,600 m ↙ 1,015 m

Ferramentas:



Martelo



Chave Fenda



Chave Philips

Quantidade de Montadores:

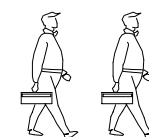

INSTRUÇÕES

- Prepare a montagem do móvel próximo ao local que ele ficará definitivamente e evite deslocá-lo depois de montado;
- Forre o chão com papelão ou similar e utilize a isomanta que vem entre as peças para evitar o contato entre elas durante a montagem;
- Monte o móvel obedecendo a ordem numérica da **sequência de montagem**, identificando as peças pelo **código de peça**.

CUIDADOS ESPECIAIS COM A LIMPEZA

LIMPEZA MADEIRA: Pano limpo umedecido em água e sabão neutro - BRILHO: Flanela seca

Data atualização

10.01.2023

CÓDIGO DE PEÇAS

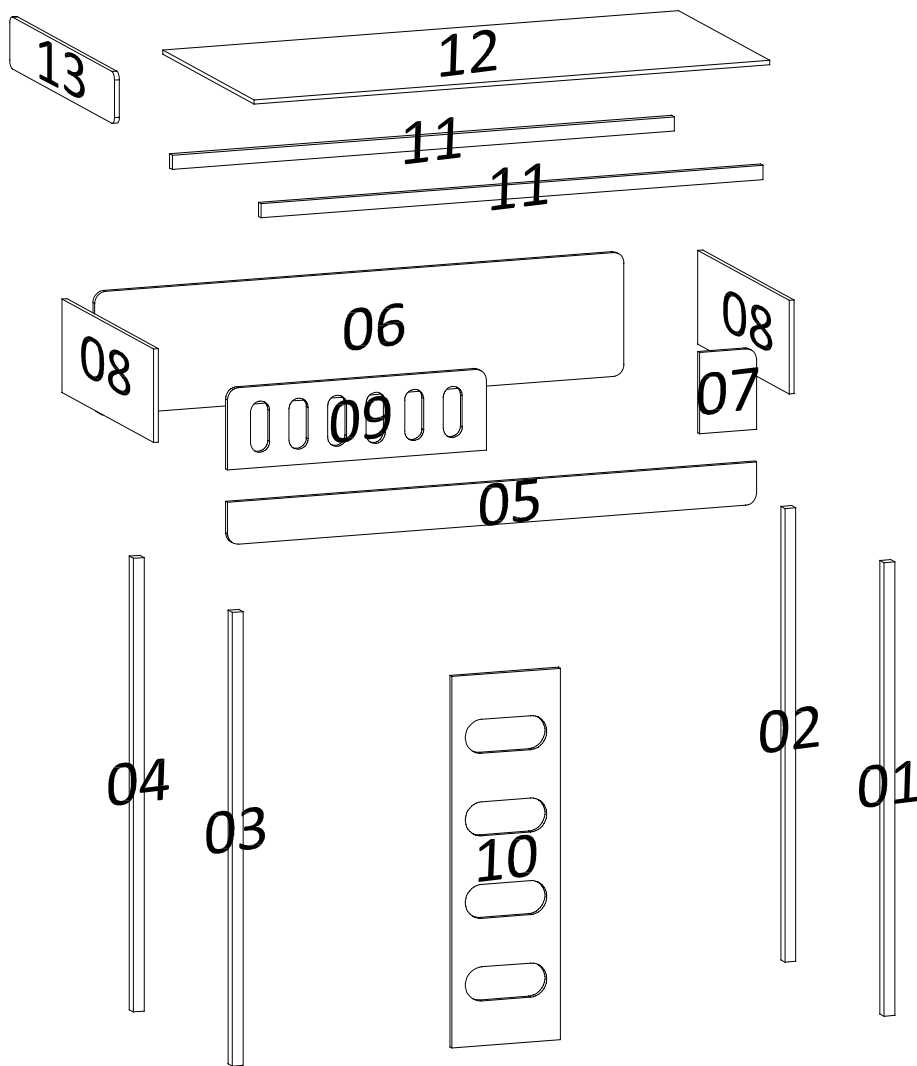

Código:	PEÇAS	DIMENSÕES	*Dimensões em metros QUANTIDADE
01	PÉ CABECEIRA DIREITA BELICHE FRONTAL	1,600 x 0,040 x 0,040	1
02	PÉ CABECEIRA DIREITA BELICHE TRASEIRO	1,600 x 0,040 x 0,040	1
03	PÉ CABECEIRA ESQUERDO BELICHE FRONTAL	1,600 x 0,040 x 0,040	1
04	PÉ CABECEIRA ESQUERDO BELICHE TRASEIRO	1,600 x 0,040 x 0,040	1
05	BARRA AUXILIAR	1,950 x 0,150 x 0,018	2
06	ENCOSTO TRASEIRO	1,950 x 0,437 x 0,018	2
07	COMPLEMENTO DE BARRA AUXILIAR	0,210 x 0,287 x 0,018	2
08	CABECEIRA	0,900 x 0,330 x 0,018	4
09	ENCOSTO FRONTAL	0,954 x 0,287 x 0,018	2
10	ESCADA	1,310 x 0,400 x 0,018	1
11	CORDÃO ESTRADO	1,850 x 0,050 x 0,025	4
12	CHAPA ESTRADO	1,900 x 0,900 x 0,015	2
13	COMPLEMENTO PÉS	1,016 X 0,180 X 0,018	2



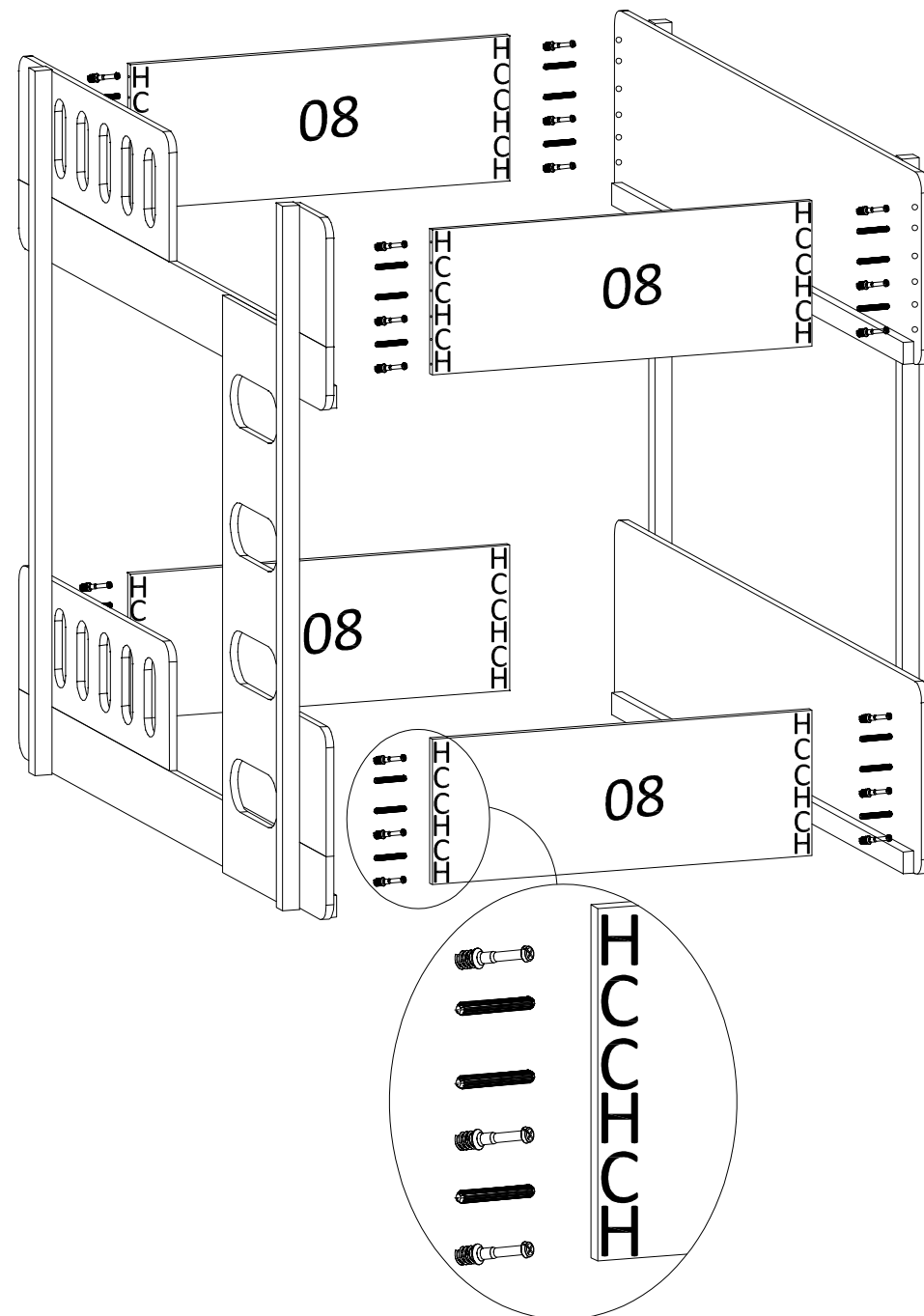

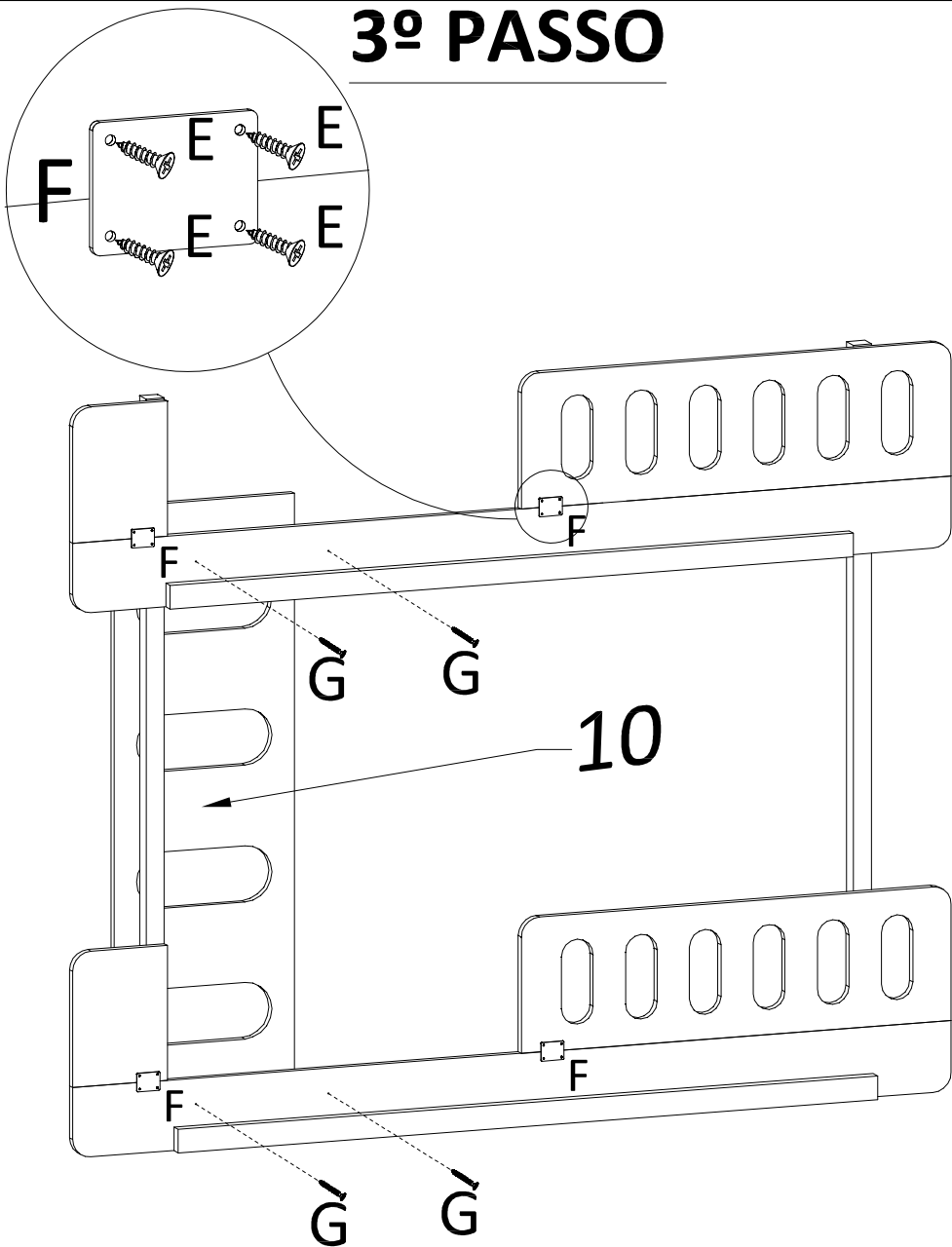

4º PASSO

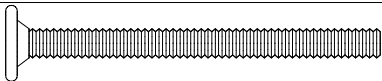

3º PASSO

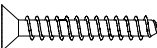

ACESSÓRIOS

Código:	DESCRIÇÃO	QUANTIDADE
A	 Parafuso 4,5 x 40	28
B	 Parafuso 1/4 x 50	16
C	 Cavilha 8 x 30	40
D	 Porca Cilindrica	16
E	 Parafuso 4,0 x 14	16
F	 Chapa Plana	4
G	 Parafuso 4,5 x 30	16
H	 Pino e Castanha Girofix	24

1º PASSO

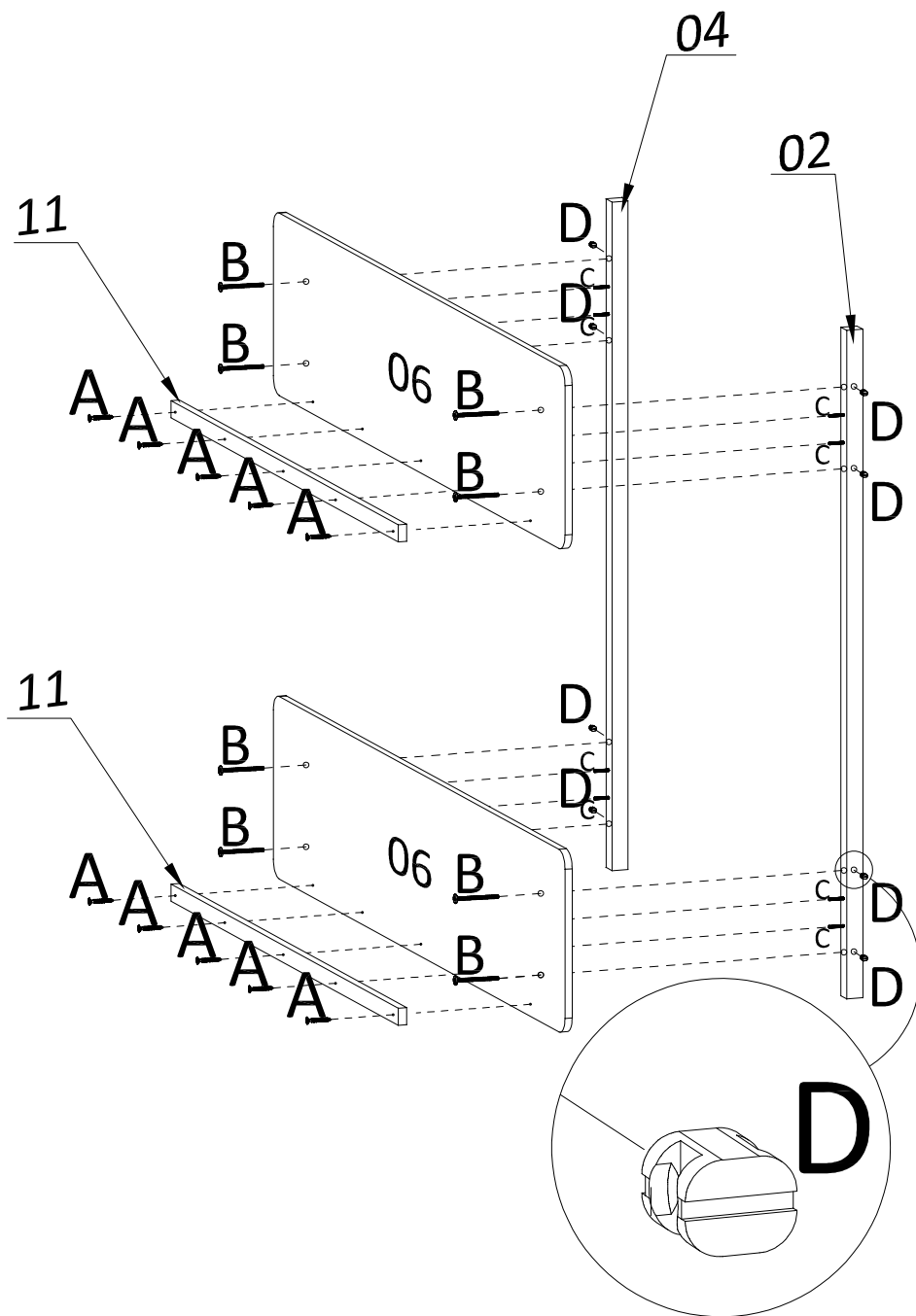

2º PASSO

