

**2º PASSO**

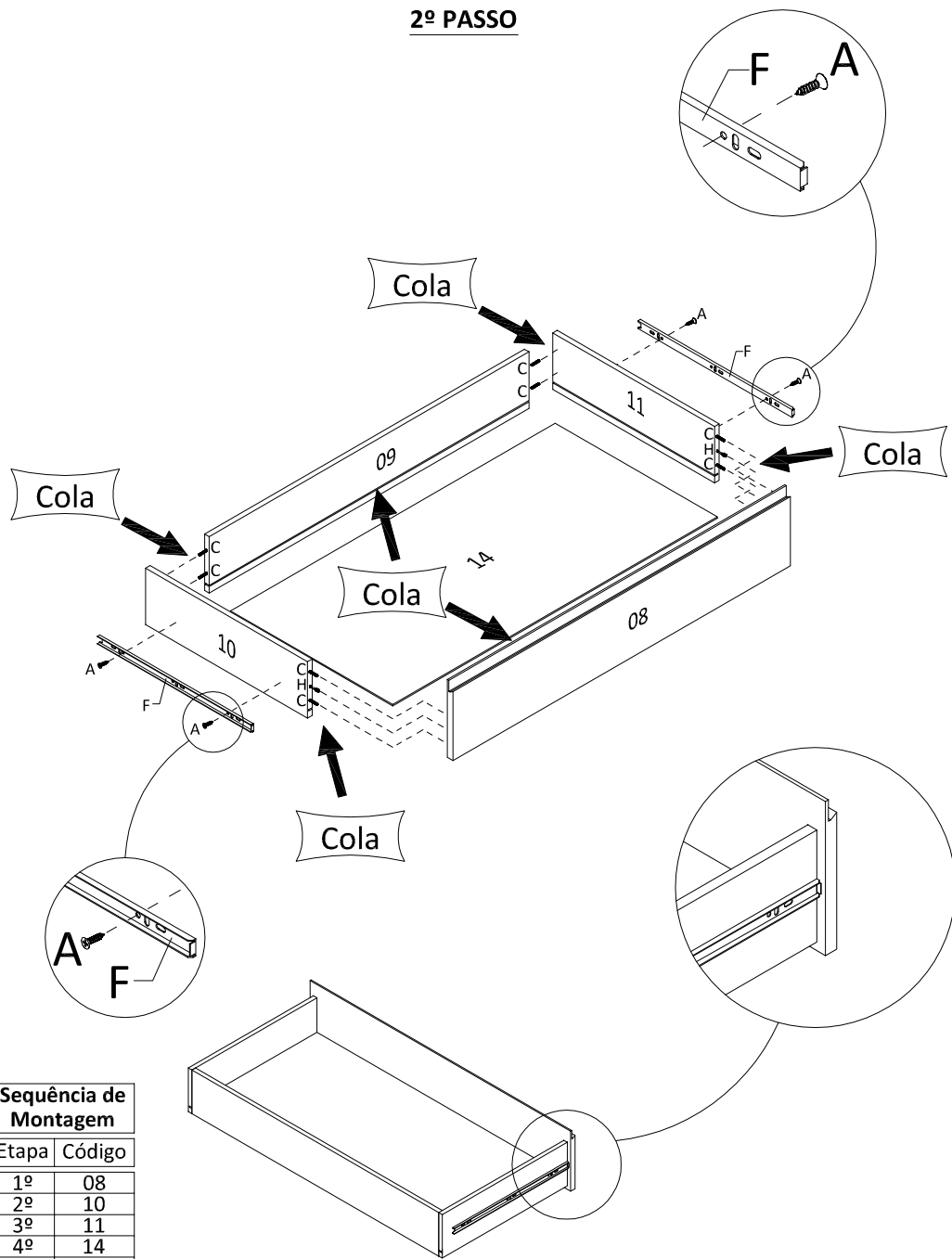

Sequência de Montagem	
Etapa	Código
1º	08
2º	10
3º	11
4º	14
5º	09

**CUIDADOS ESPECIAIS COM A LIMPEZA**

LIMPEZA MADEIRA: Pano limpo umedecido em água e sabão neutro - BRILHO: Flanela seca

Data atualização

02.02.2016

**Somniare**

Móveis Infante-Juvenis

**Cômoda - LM 3072**

**ESQUEMA DE MONTAGEM**

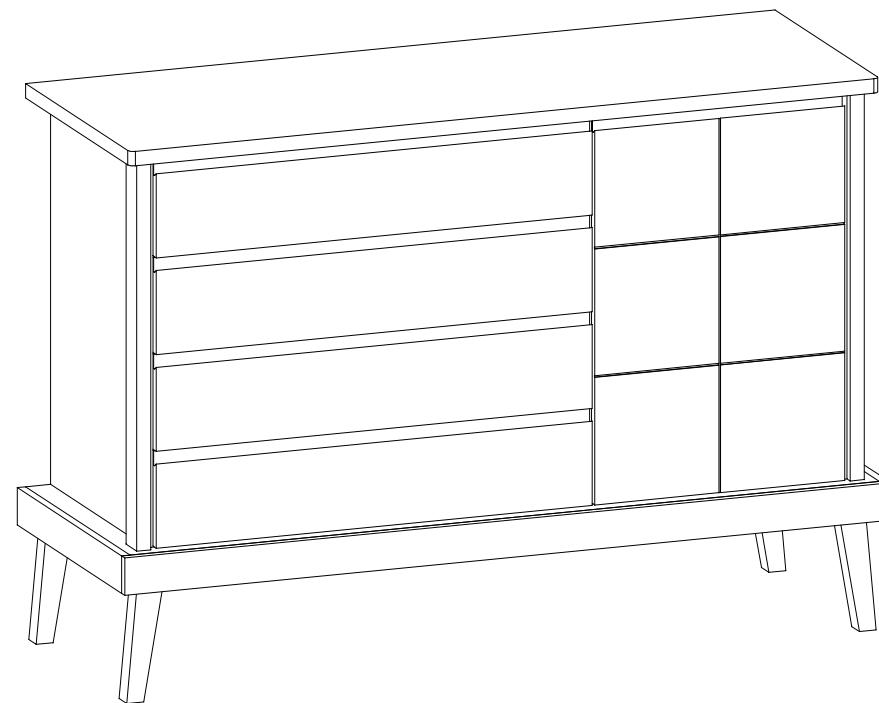

→ 1,350 m ↑ 0,960 m ↙ 0,490 m

**Ferramentas:**

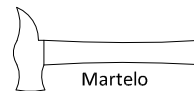

Martelo



Chave Fenda



Chave Philips

**Quantidade de Montadores:**



**INSTRUÇÕES**

- Prepare a montagem do móvel próximo ao local que ele ficará definitivamente e evite deslocá-lo depois de montado;
- Forre o chão com papelão ou similar e utilize a isomanta que vem entre as peças para evitar o contato entre elas durante a montagem;
- Monte o móvel obedecendo a ordem numérica da **sequência de montagem**, identificando as peças pelo **código de peça**.







Atendimento ao consumidor  
tel +55 43 3256 0017  
contato@kykmoveis.com.br

**KYK Ind e Comércio Móveis Ltda.**  
Rua Ivai 275 | Parque Industrial  
CEP 86600-000 | Rolândia | PR | Brasil  
[www.somniare.com.br](http://www.somniare.com.br)

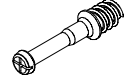
## ACESSÓRIOS

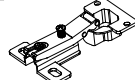
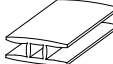
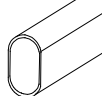
Código:	DESCRIÇÃO	QUANTIDADE
<b>A</b>	 Parafuso 4,0 x 12	<b>56</b>
<b>B</b>	 Cantoneira	<b>6</b>
<b>C</b>	 Cavilha 8 x 30	<b>46</b>
<b>D</b>	 Parafuso 4,5 x 35	<b>12</b>
<b>E</b>	 Prego 10 x 10	<b>60</b>
<b>F</b>	 Corrediça Telescópica	<b>4</b>

<b>G</b> 5	<b>H</b> 22	<b>J</b> 22	<b>K</b> 2	<b>L</b> 2
				
Fixador de fundo	Pino Girofix	Castanha Girofix	Sache de Cola	Dobradiça / Calço
<b>M</b> 1	<b>N</b> 1	<b>O</b> 2		
				
Perfil "H"	Bastão	Suporte Cabideiro		

\*Dimensões em metros

Código:	PEÇAS	DIMENSÕES*	QUANTIDADE
01	Tampo	1,350 x 0,490 x 0,025	1
02	Base	1,350 x 0,490 x 0,025	1
03	Moldura Lateral	0,675 x 0,050 x 0,025	2
04	Lateral Direita	0,675 x 0,450 x 0,015	1
05	Lateral Esquerda	0,675 x 0,450 x 0,015	1
06	Divisão Vertical	0,675 x 0,450 x 0,015	1
07	Porta	0,670 x 0,450 x 0,015	1
08	Frente de Gaveta	0,785 x 0,166 x 0,015	4
09	Contra Fundo	0,726 x 0,130 x 0,012	4
10	Lateral Gaveta Esquerda	0,430 x 0,130 x 0,012	4
11	Lateral Gaveta Direita	0,430 x 0,130 x 0,012	4
12	Vista Lateral	0,490 x 0,065 x 0,015	2
13	Vista Frontal	1,380 x 0,065 x 0,015	1
14	Fundo de Gaveta	0,740 x 0,430 x 0,003	4
15	Fundo da Porta	0,695 x 0,458 x 0,003	1
16	Fundo do Gaveteiro	0,695 x 0,392 x 0,003	2

